

# HOMESTORY

WOHNEN, WIE ES DIR GEFÄLLT.

BETRIEBSANLEITUNG

POLSTER



SO 4300

(Bitte aufbewahren) (Stand 04.06.2021)

**set**one  
by Musterring

# Nutzen Sie die Sicherheit einer großen Marke.



## 5 Jahre Garantie.

Auf set one Möbel ist Verlass.

Die Garantiebestimmungen, Gebrauchs- und Pflegeanweisungen sind im set one Möbel-Gütepass geregelt.



## Service-Information

Sie erreichen uns per E-Mail oder über das Servicetelefon zu den üblichen Geschäftszeiten.



## Individualität

Die set one Produktkennzeichnung belegt, dass Sie ein Unikat gekauft haben.



## Pflege

Wir empfehlen Musterring Pflegeprodukte.

## Lederpflege & Reinigung

## Stoff-/ Mikrofaserpflege & Reinigung

## Holzpflege und Sonderprodukte



Zu bestellen unter [www.musterring-care.com](http://www.musterring-care.com) oder unter der kostenlosen Beratungsnummer + 49 (0) 800 / 88 88 885.

Bei Fragen sprechen Sie uns bitte an; wir helfen Ihnen gerne weiter.

## Zur Werterhaltung Ihrer Möbel

# Unsere Pictogramme mit Erläuterungen

## Aufbau

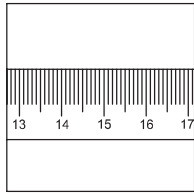

Maßangaben in den Preis- und Typenlisten beachten



Neu-/Umbauten sind vor der Lieferung abzuschließen

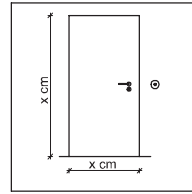

Stellflächen müssen eben und frei zugänglich sein

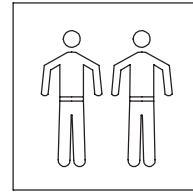

Lieferung und Montage nur durch Fachpersonal

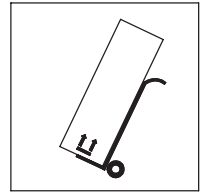

Verpackungsrichtlinien und Transporthinweise beachten

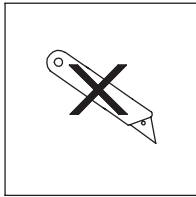

Nicht durch die Verpackung schneiden

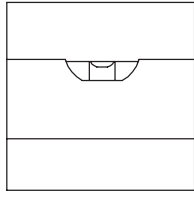

Genaueres Ausrichten mit der Wasserwaage erforderlich

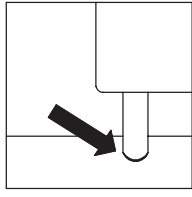

Möbelfüße/-gleiter sind den Fußböden anzupassen

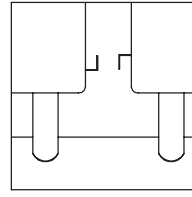

Elementverbindungen nach Herstellervorgaben

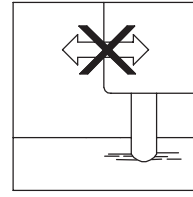

Montagezustand nicht ohne Demontage verändern

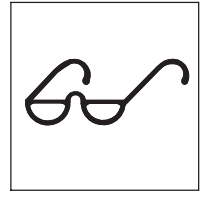

Abnahme durch Sicht- und Funktionsprüfung

## Betrieb

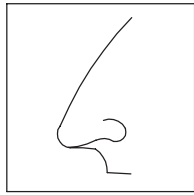

Neumöbelgeruch ist material- und warentypisch

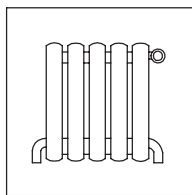

Mindestabstand zu Heizquellen beachten

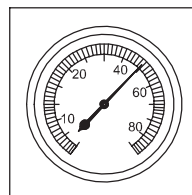

Empfohlenes Raumklima  
Ø 45-55% Luftfeuchte

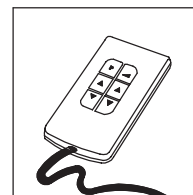

Betriebsanleitung beachten

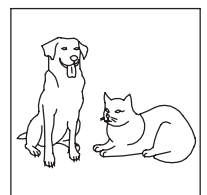

Haustiere schaden Bezügen bzw. Oberflächen

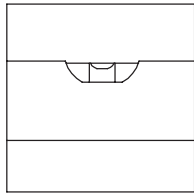

Genaueres Ausrichten mit der Wasserwaage erforderlich

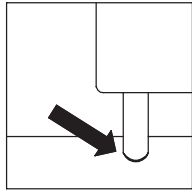

Möbelfüße/-gleiter sind den Fußböden anzupassen

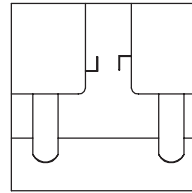

Elementverbindungen nach Herstellervorgaben

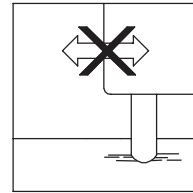

Montagezustand nicht ohne Demontage verändern

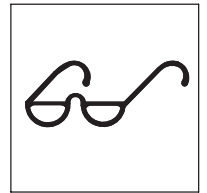

Abnahme durch Sicht- und Funktionsprüfung

## Wartung

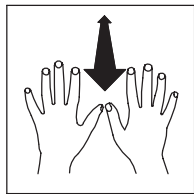

Polsterbezüge regelmäßig aufklappen

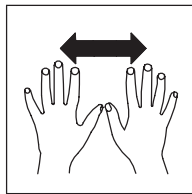

Polsterbezüge regelmäßig glätten

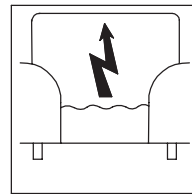

Statische Aufladung der Bezüge möglich

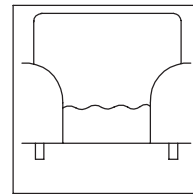

Legerer Polsteraufbau neigt zur Wellenbildung

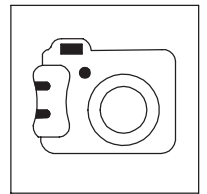

Im Schadenfall Foto: Gesamt-, Detailansicht

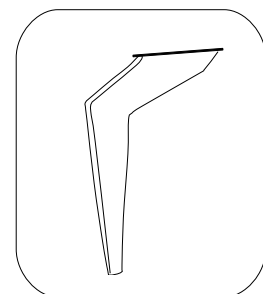
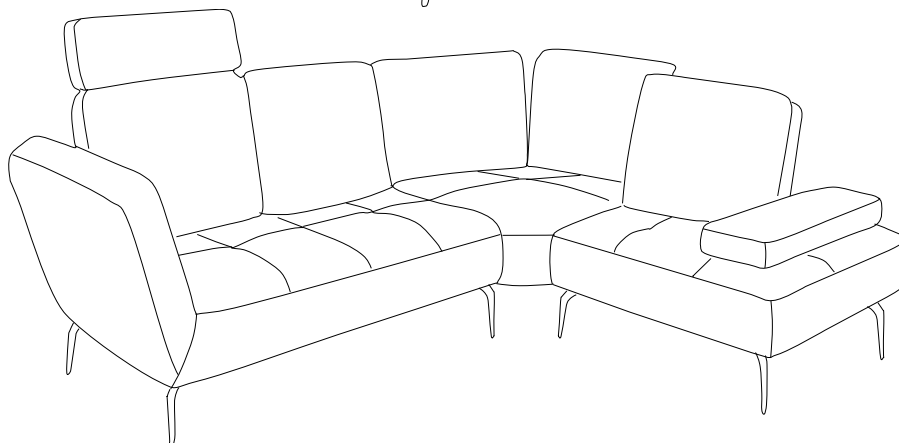
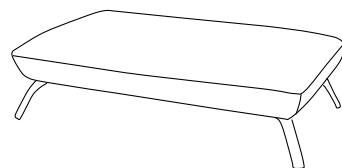
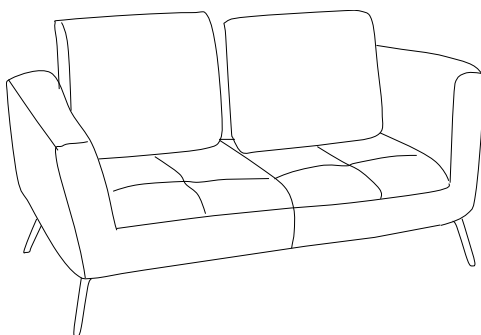
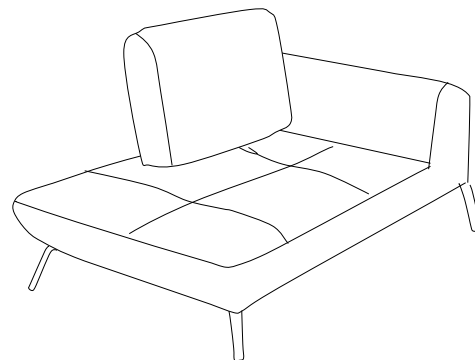
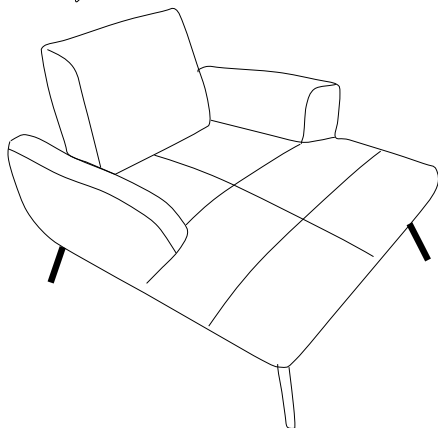
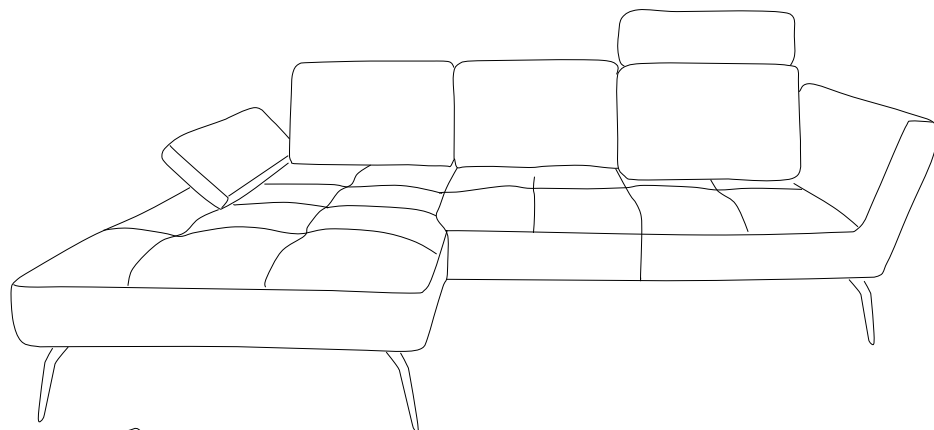
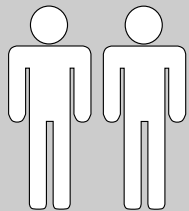



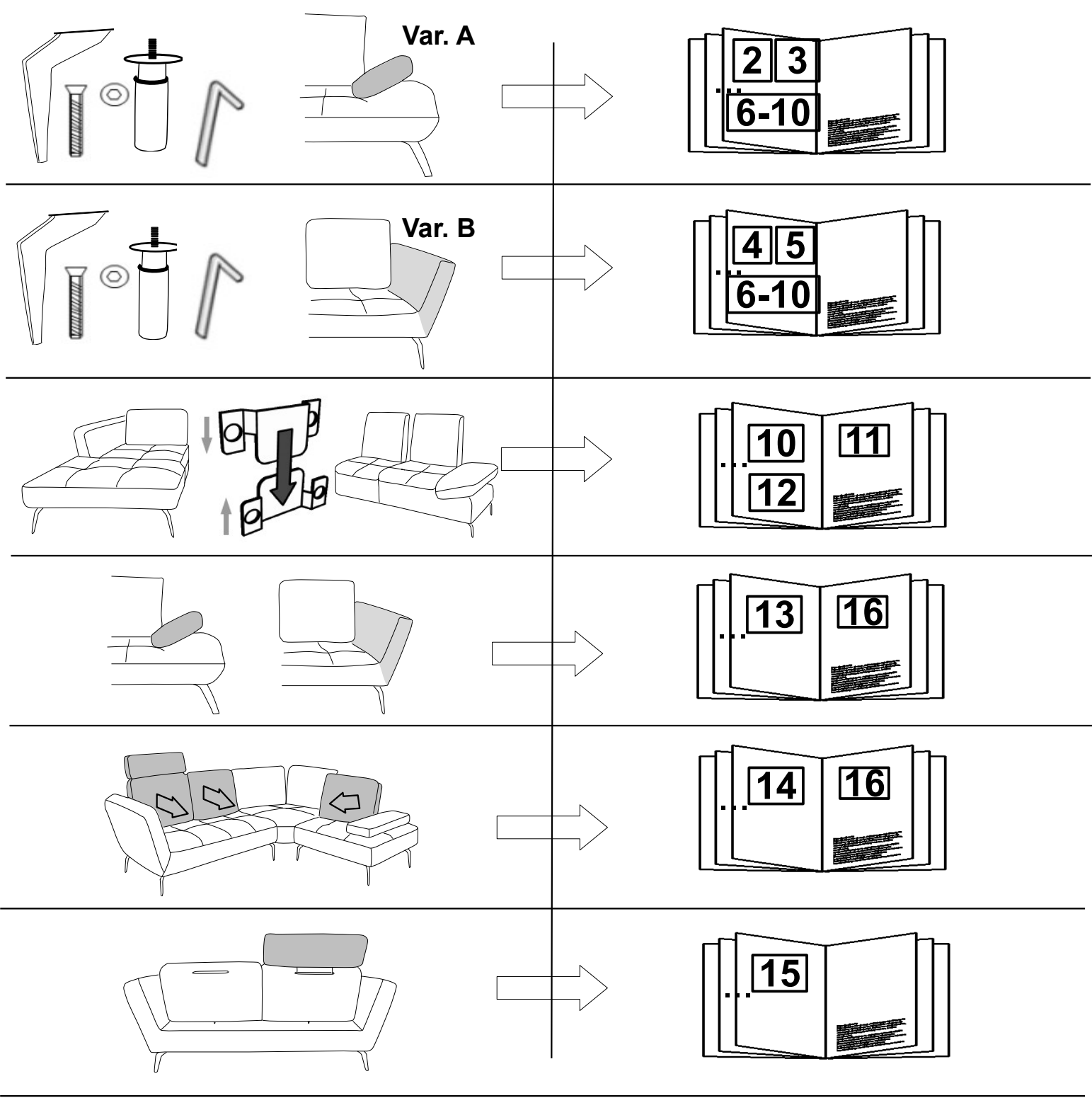

# SO 4300







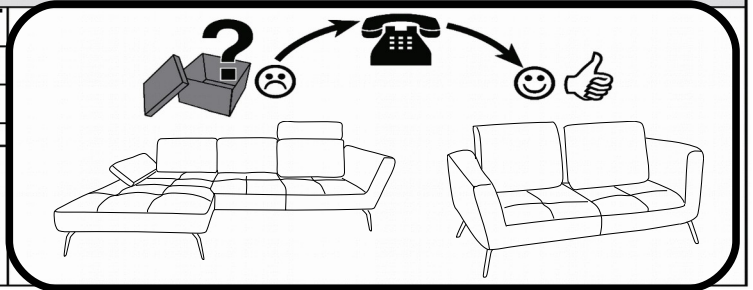
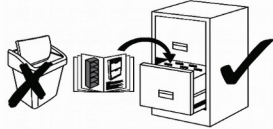

Service · Dienstverlening · Serwis · Servis · Сервисная служба · Serviciu ·  
Services · Servizio · Servisný list · Szolgáltatás · Servisní list

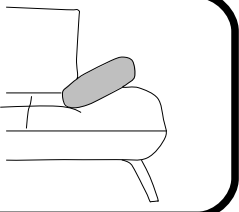

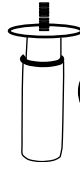

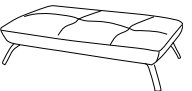

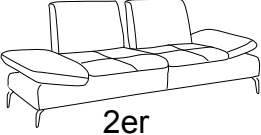
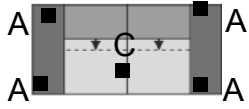
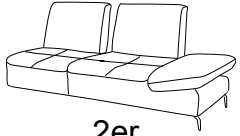
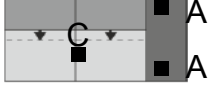
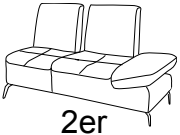
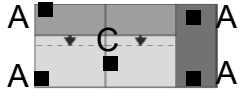
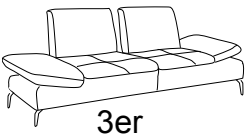

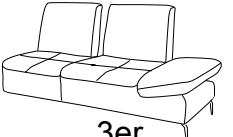
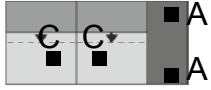
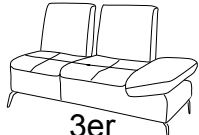
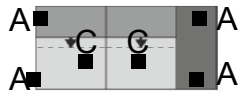
Name · Naam · Nazwa · Ísim · Название · Nume · Nome ·  
Názov · Názov · Název · Neve

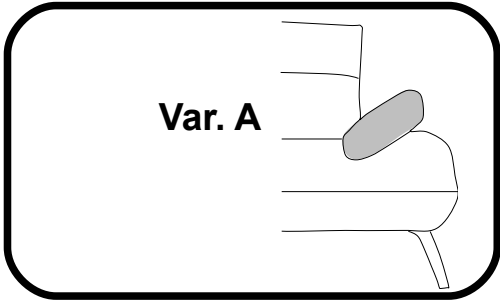
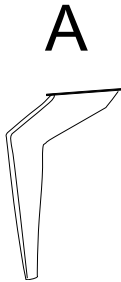
SO 4300

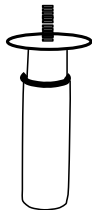
Тур · Туре · Тір · Тип · Тіро · Тірус

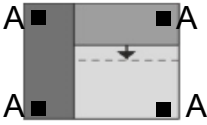
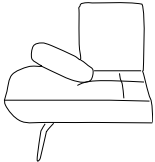

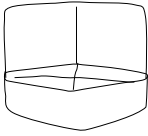
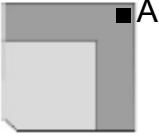
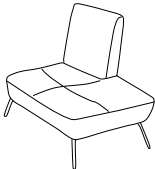
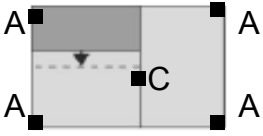
✓	Var. A		 A	 B M6x25	 C	 D 4L
			4A	4x4B	/	
	 2er		4A	4x4B	1C	
	 2er		2A	2x4B	1C	
	 2er		4A	4x4B	1C	1D
	 3er		4A	4x4B	2C	
	 3er		2A	2x4B	2C	
	 3er		4A	4x4B	2C	

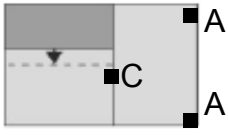
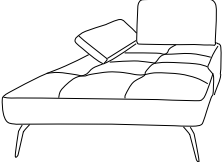
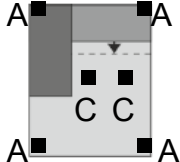
✓			 M6x25		 4L	
			4A	4x4B	/	1D
			2A	2x4B	/	
			1A	1x4B	/	
			4A	4x4B	1C	
			2A	2x4B	1C	
			4A	4x4B	2C	



# SO 4300







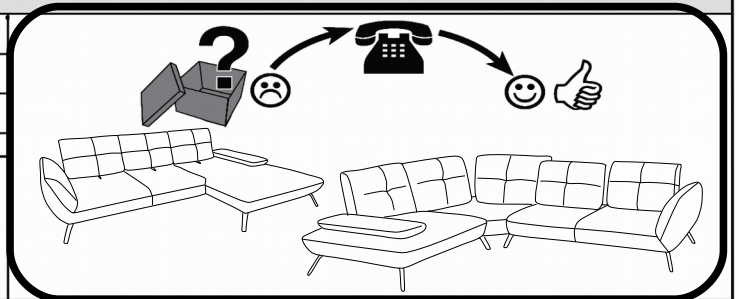
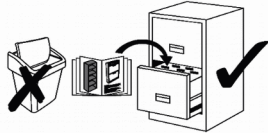

Service · Dienstverlening · Serwis · Servis · Сервисная служба · Serviciu · Services · Servizio · Servisný list · Szolgáltatás · Servisní list

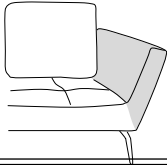
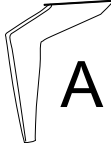
Name · Naam · Nazwa · İsim · Название · Nume · Nome ·  
Názov · Názov · Název · Neve

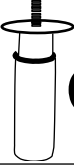



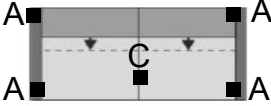
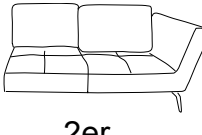
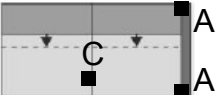
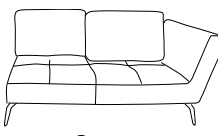
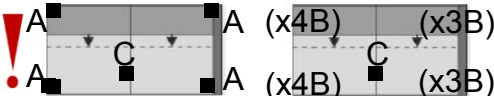
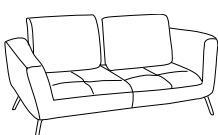
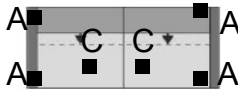
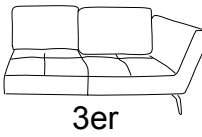
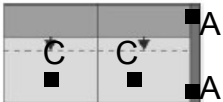
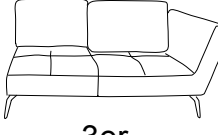





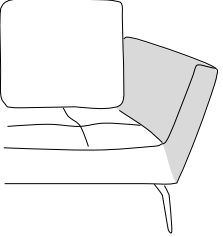

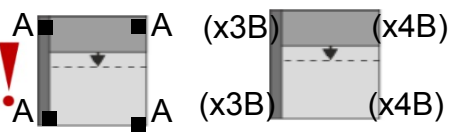
SO 4300

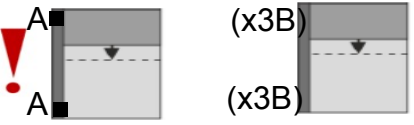
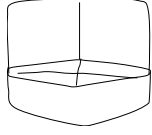
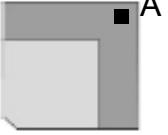
Тип · Type · Tip · Тип · Tipo · Típus

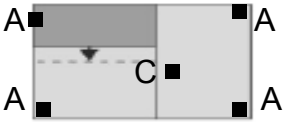

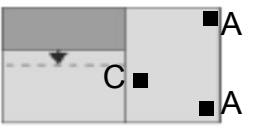
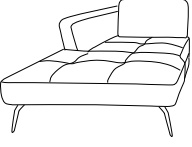
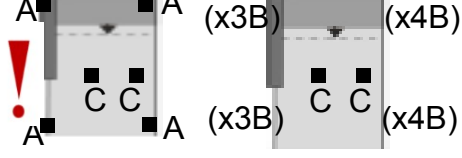
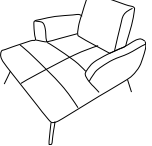
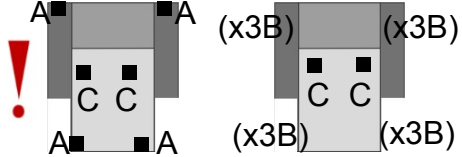
✓	Var. B		 A	 B M6x25	 C	 D 4L
			4A	4x4B	/	
	 2er		4A	4x3B	1C	
	 2er		2A	2x3B	1C	
	 2er		4A	2x3B + 2x4B	1C	1D
	 3er		4A	4x3B	2C	
	 3er		2A	2x3B	2C	
	 3er		4A	2x3B + 2x4B	2C	

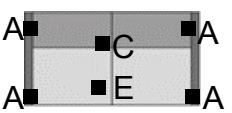
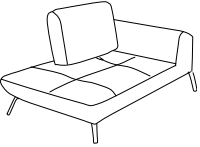
# SO 4300

✓	<div style="border: 2px solid black; border-radius: 15px; padding: 10px; display: flex; align-items: center; justify-content: center;"> <div style="margin-right: 20px;">Var. B</div>  </div>	A	B	C	D	E
			4A	2x3B + 2x4B	/	/
			2A	2x3B	/	/
			1A	1x4B	/	/
			4A	4x4B	1C	/
			2A	2x4B	1C	1D
			4A	2x3B + 2x4B	2C	/
			4A	4x3B	2C	/
	 MEGASOFA		4A	4x3B	1C	1E
			4A	2x3B + 2x4B	2C	/

# SO 4300

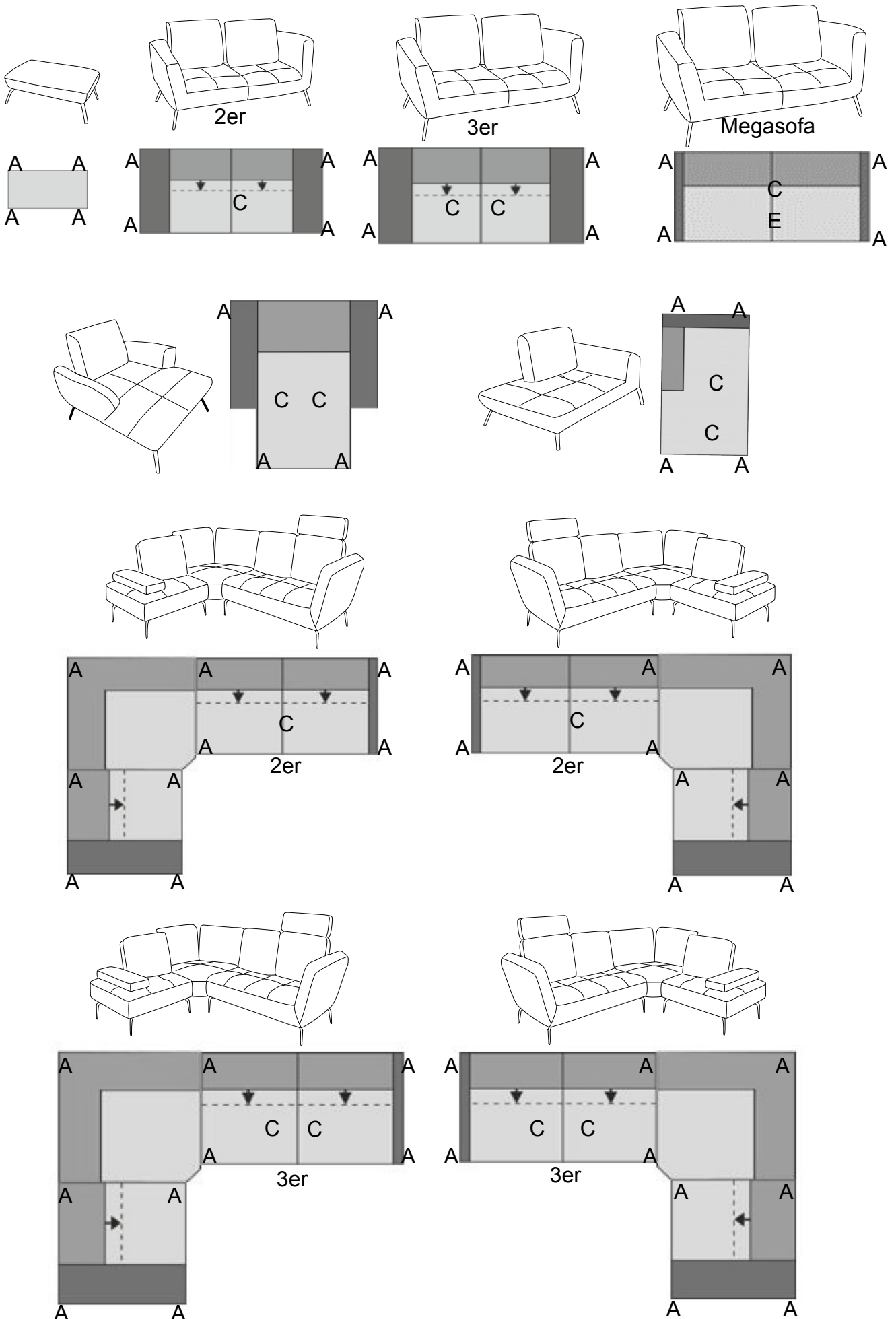

Die Piktogramme sind schematisch und können von der Wirklichkeit abweichen !

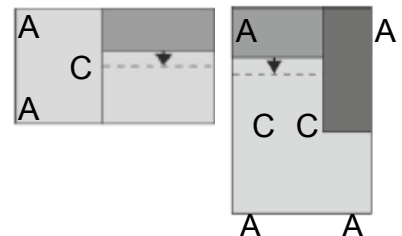
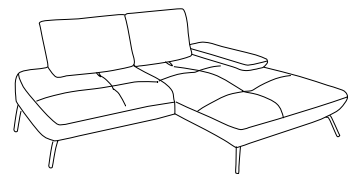
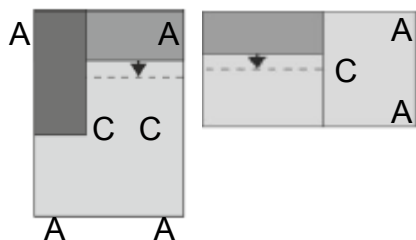
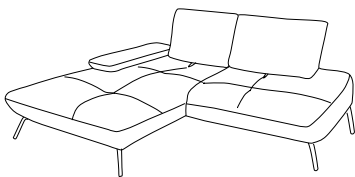
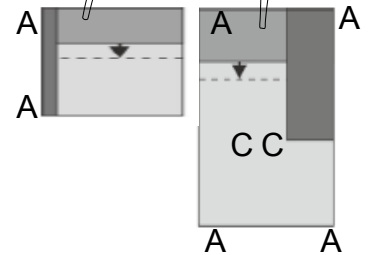
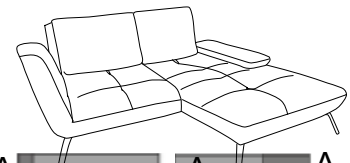
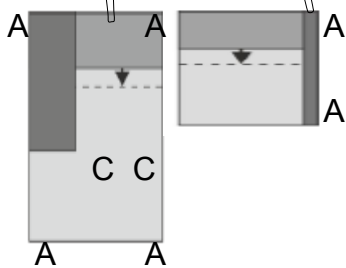
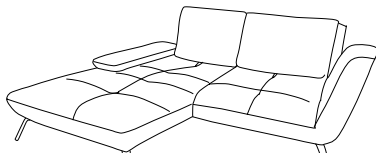
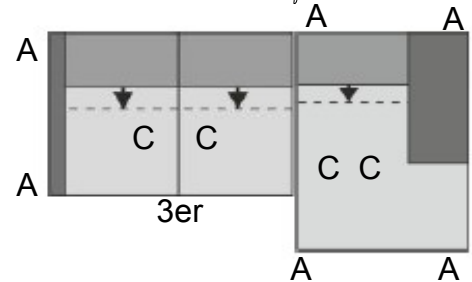
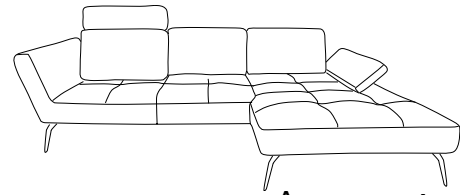
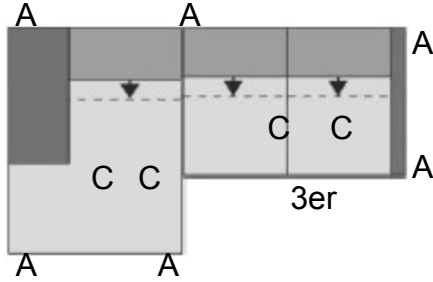
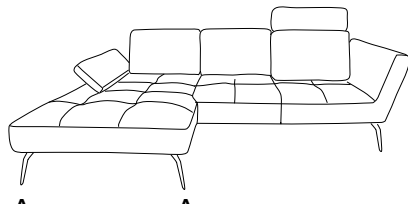
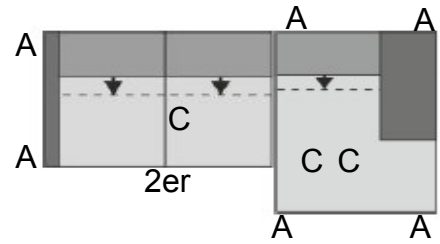
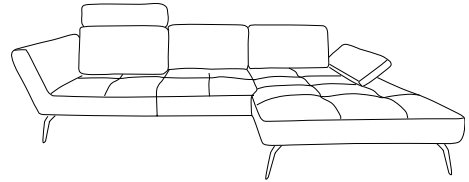
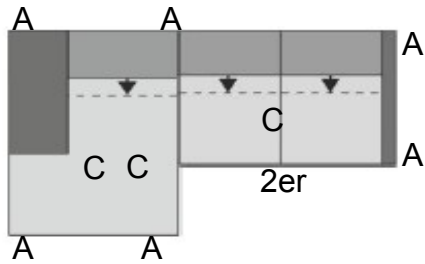
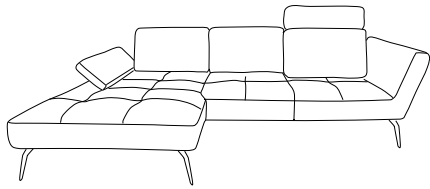

1

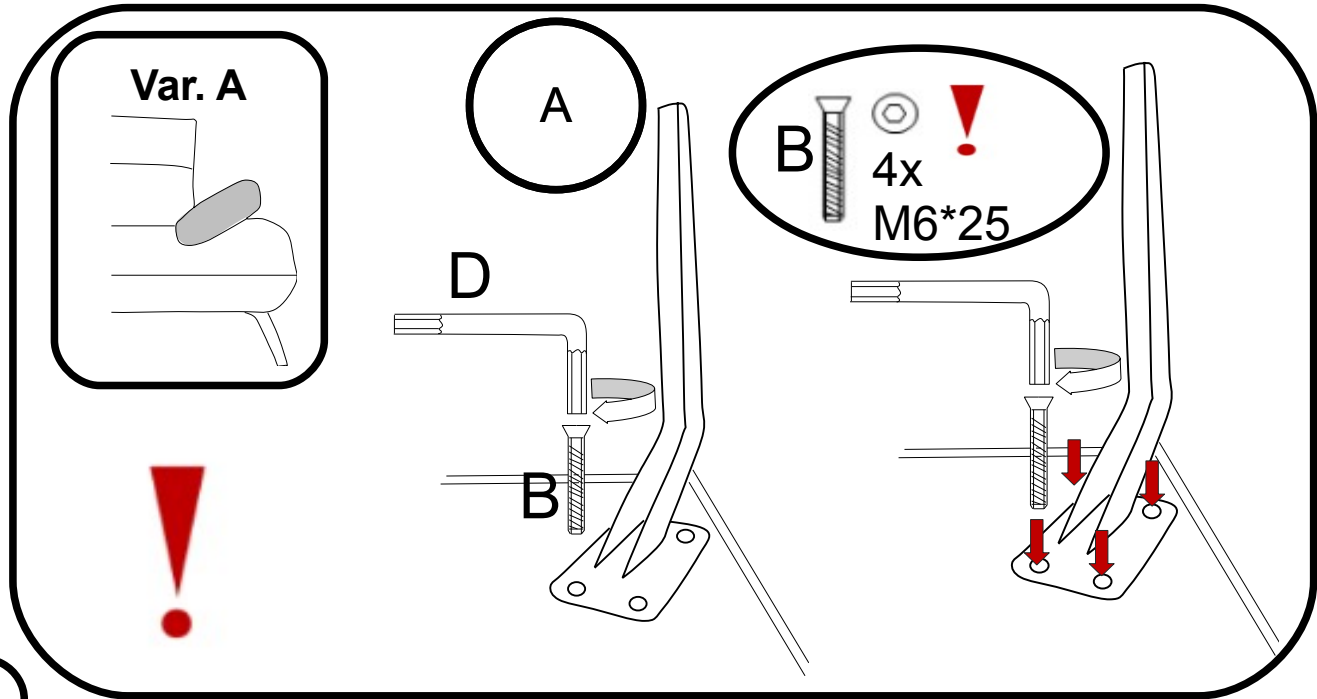
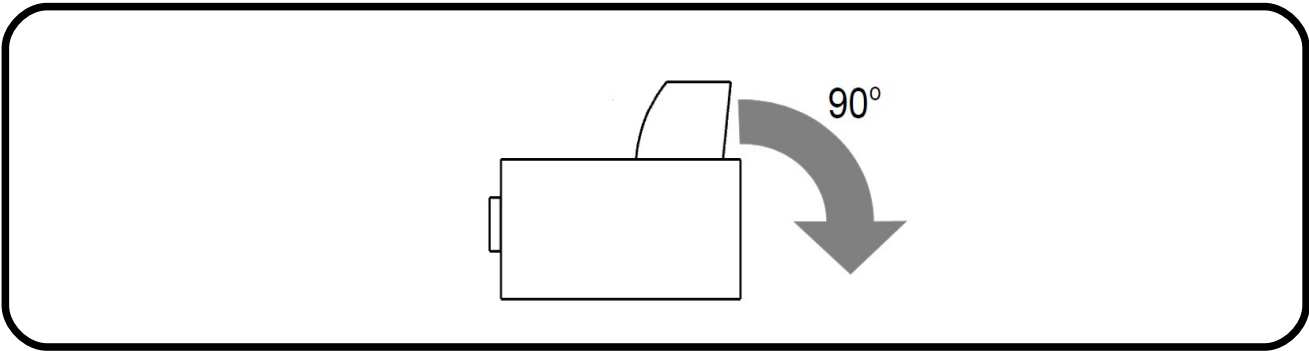

2

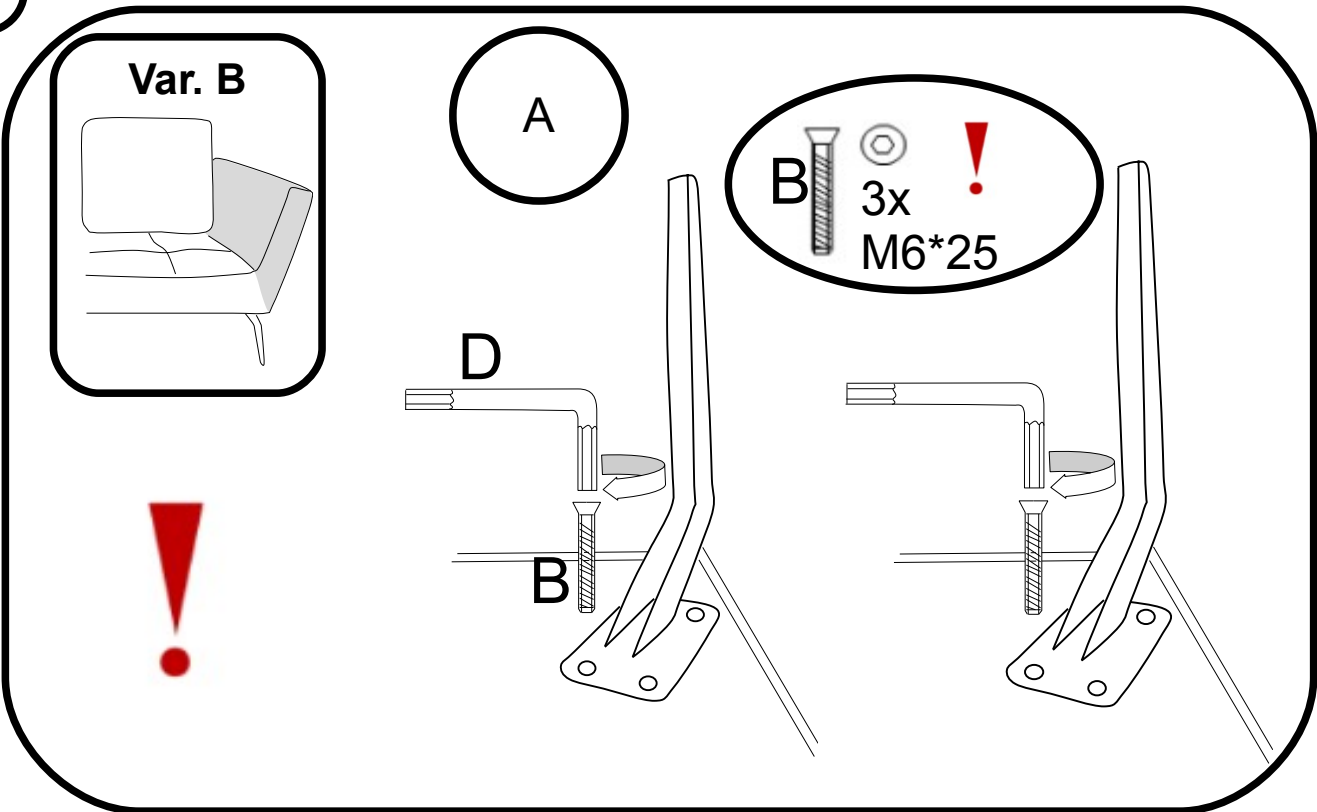



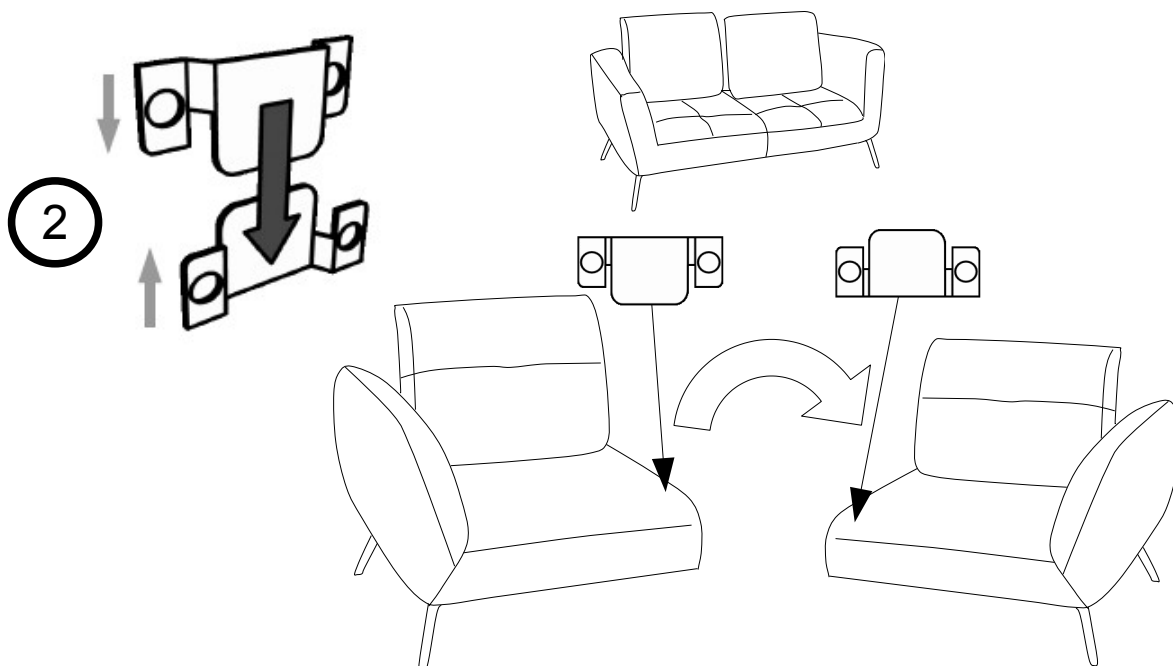
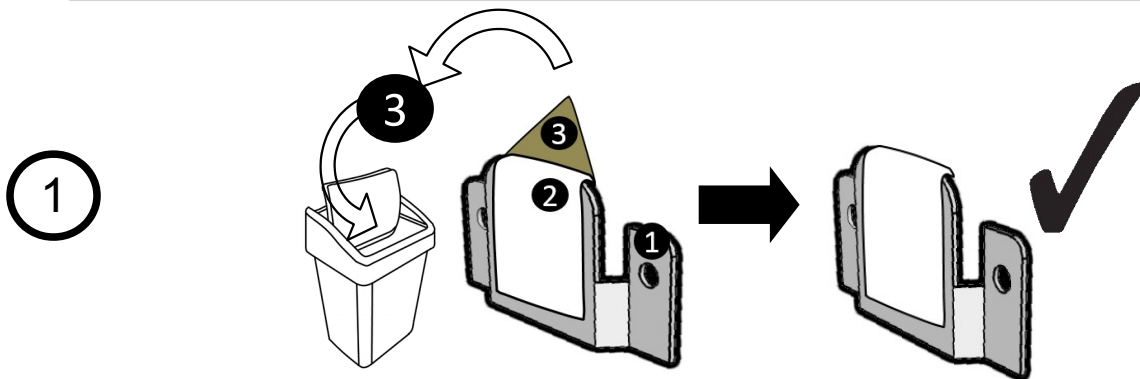
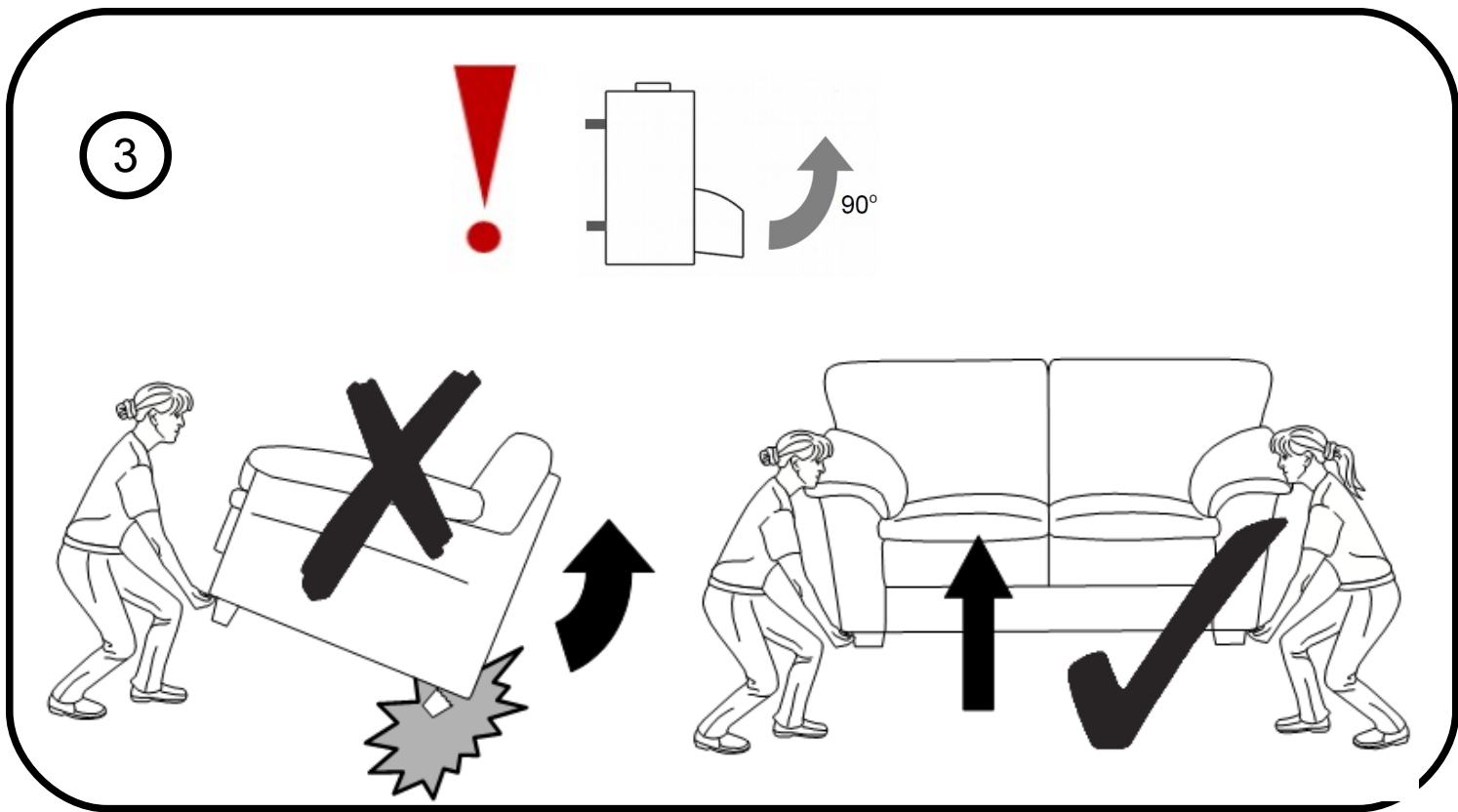

1

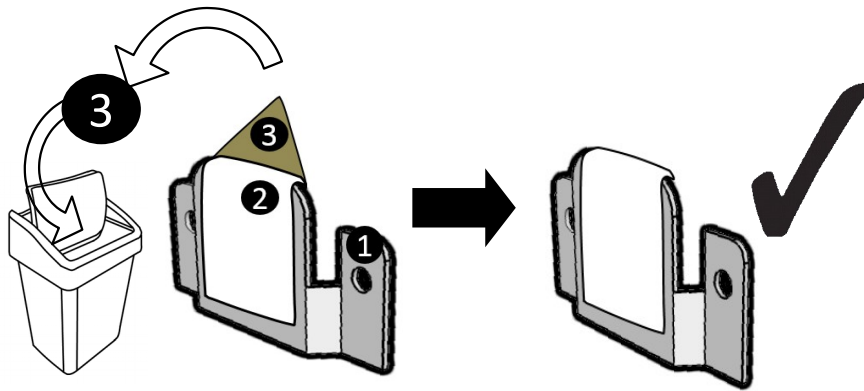

2

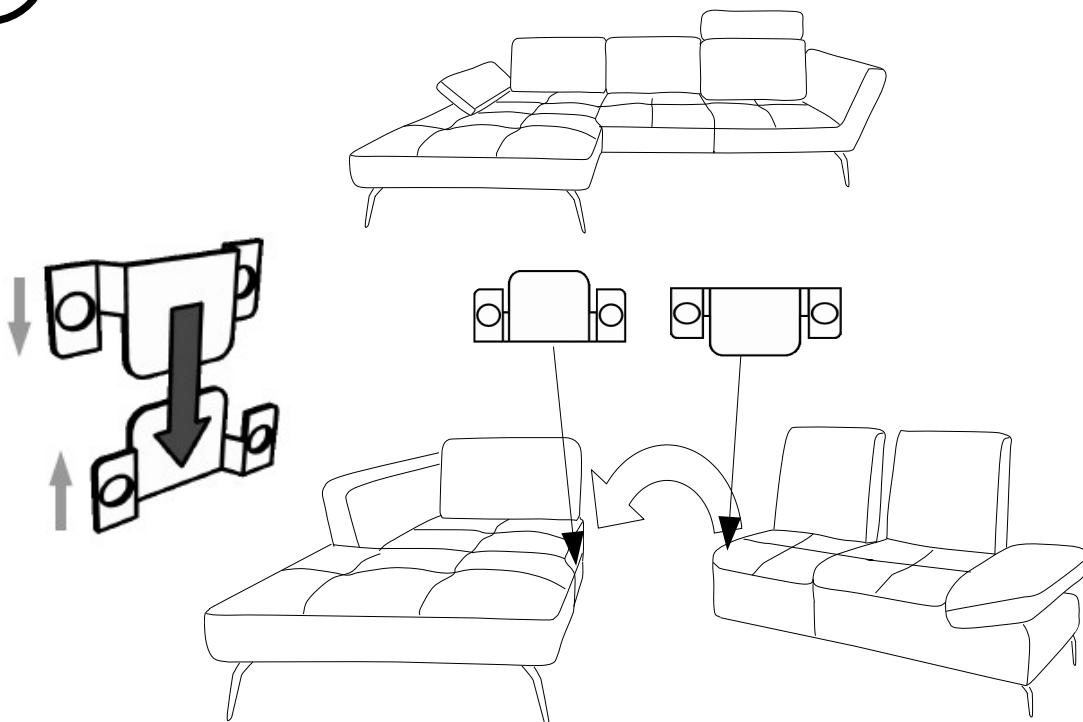
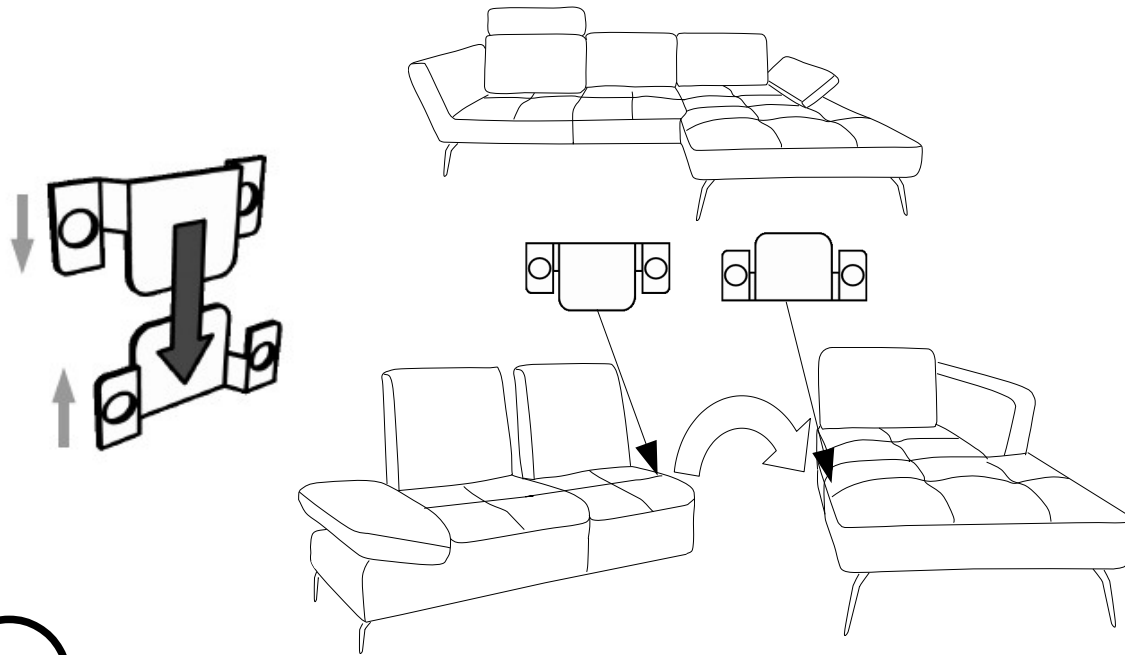



1

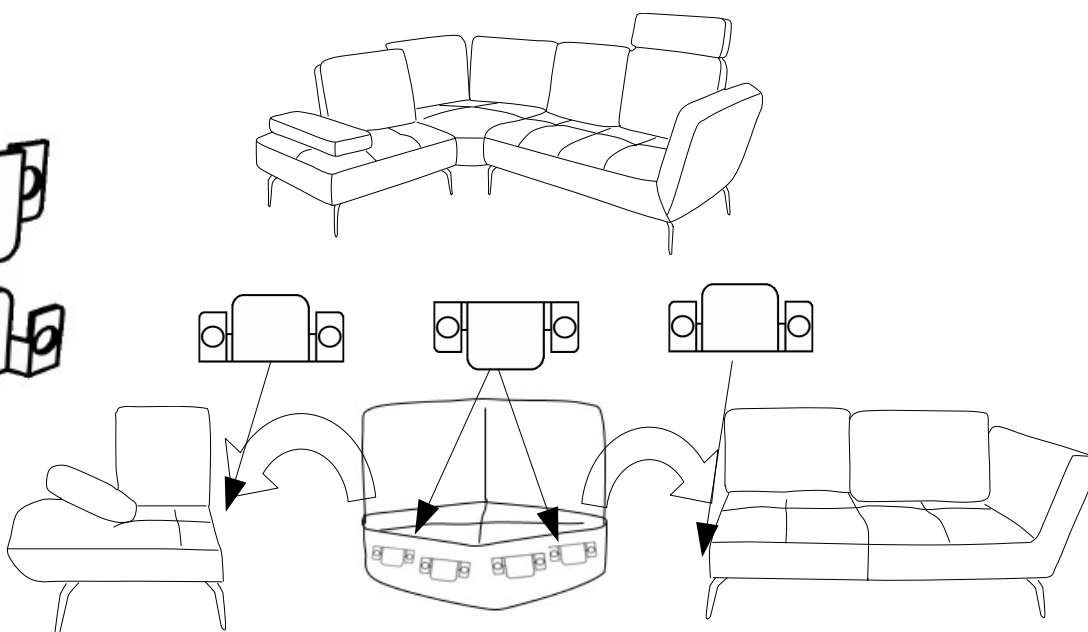
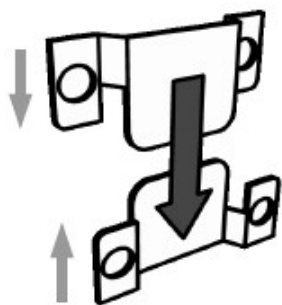
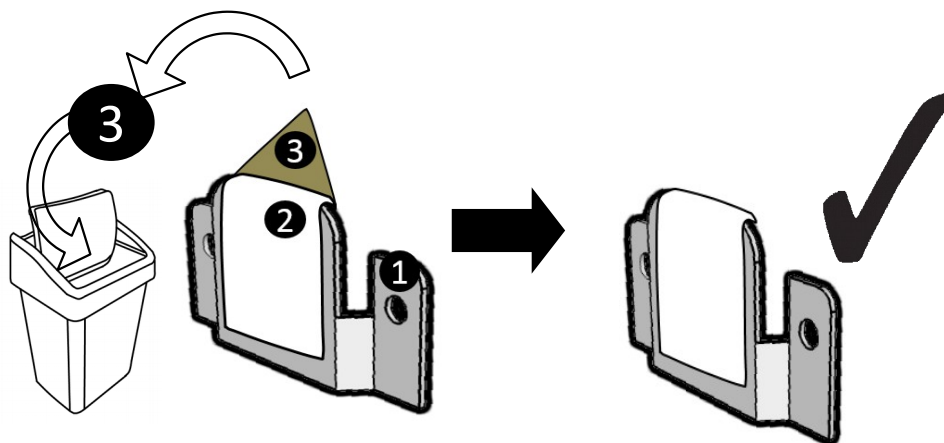

2

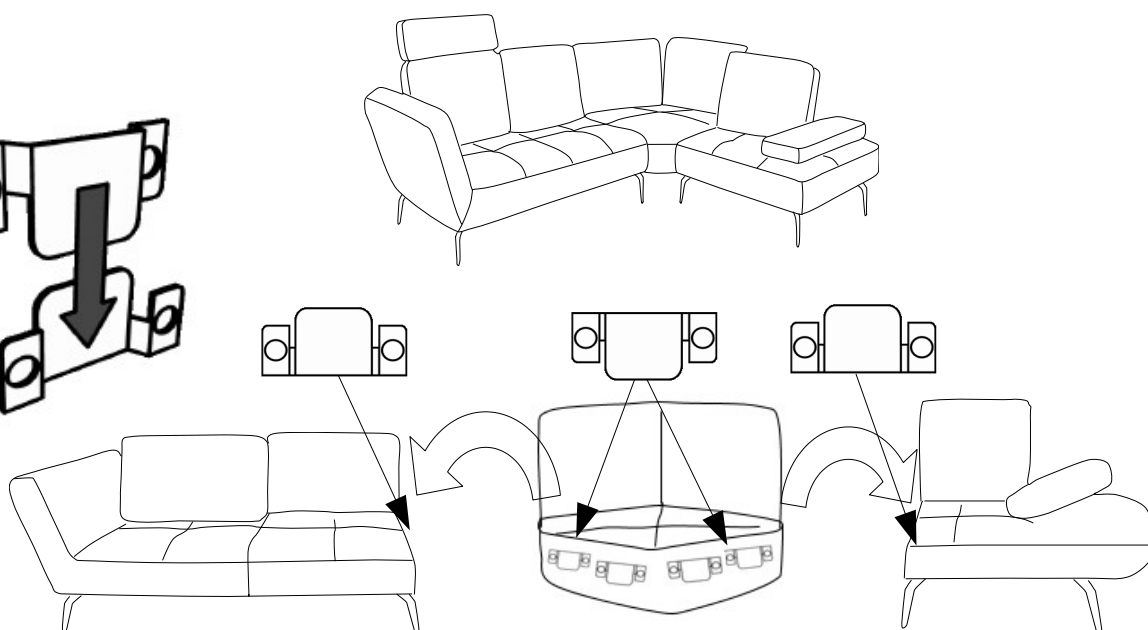
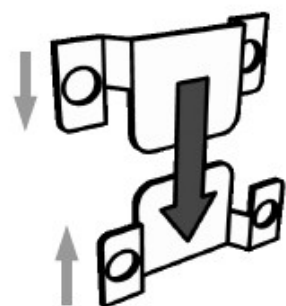

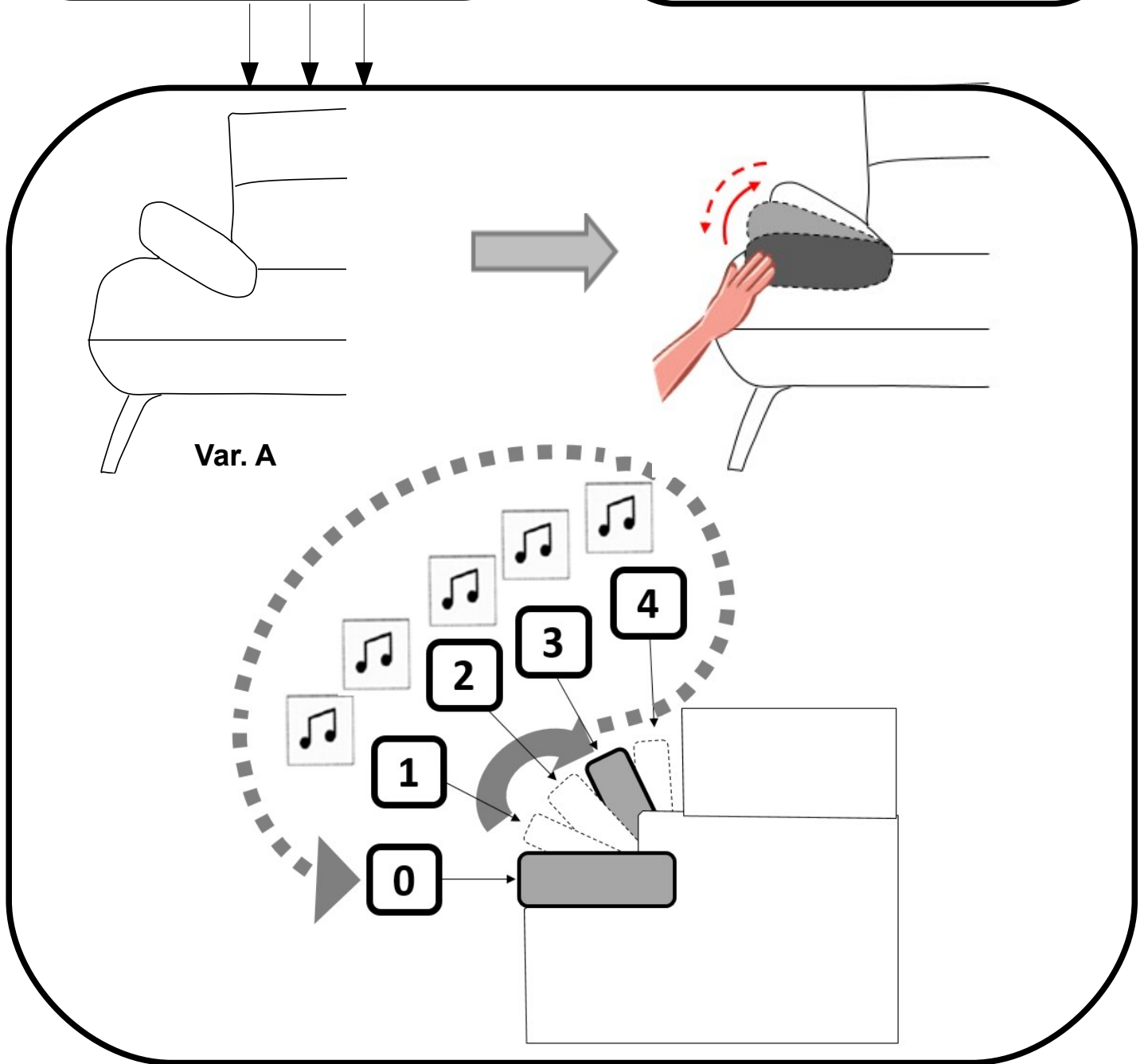
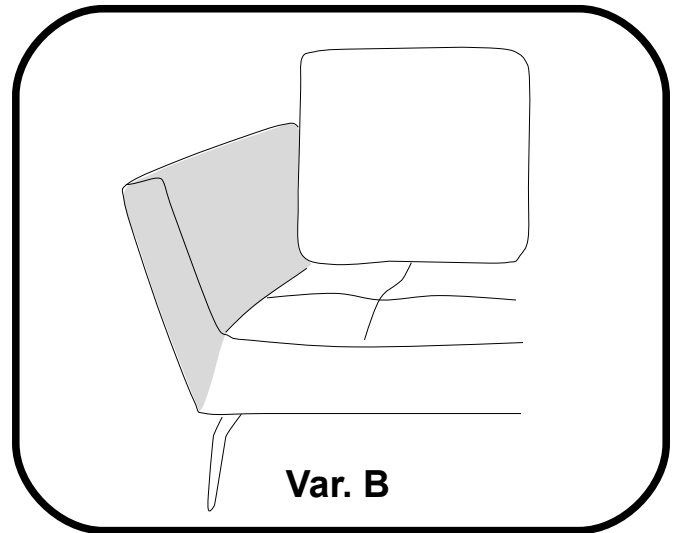
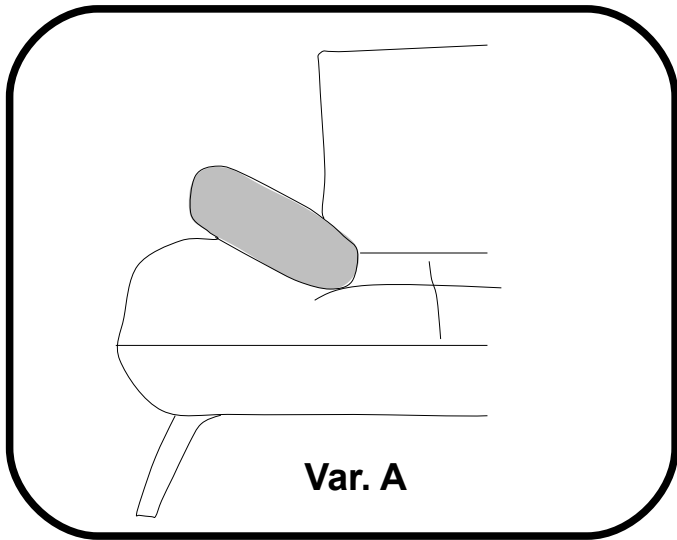

# SO 4300

